

Instructions for replacing a power supply on a TCL sign purchased after 05/01/2016.

Voltage

This sign operates within an input range of 120VAC to 277VAC.

What You Need:

- Phillips Head Screw Driver
- Needle Nose Pliers
- New Power Supply

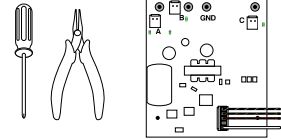

Always turn off the power prior to installation.



Be sure any metal debris cleared out of the cabinet.

Opening Sign Cabinet

1. Turn off power to sign.

2. Using a Phillips head screw driver, remove the two screws on the bottom of the cabinet. With the screws removed, open the sign by pulling the bottom of the sign forward hinging it on the top.

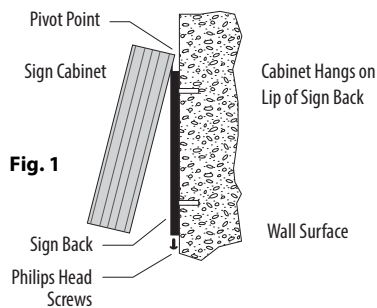

5. Locate and unplug the small white plastic connectors that wire the power supply to the bottom circuit board. The number of connectors varies by number of messages. It may be useful to label the connectors to be sure that they are replaced to the same spot on the new board. The wires may be longer than your originals but won't affect the supply at all.

Fig. 4

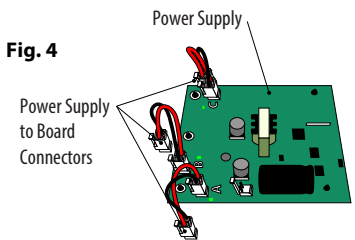

Removing Power Supply and Connections

3. Locate and unplug the large white plastic wiring harness for the incoming power. This will allow the sign cabinet to be separated from the back.

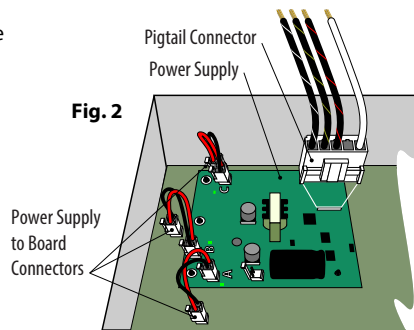

Install New Power Supply

6. Place the new power supply on the plastic snap locks and push down engaging all five of them.

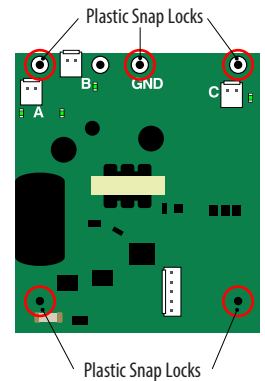
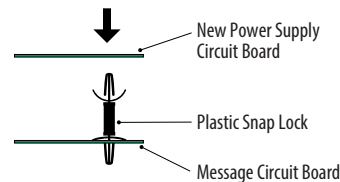

4. Place the sign face down on a clean protective surface to avoid scratching the face. Locate the five (5) black plastic snap locks (Christmas trees) holding the power supply to the circuit board. Use needle nose pliers or your fingernail to squeeze the top of the snap lock and pull up on the power supply. Continue around the power supply until it is removed.

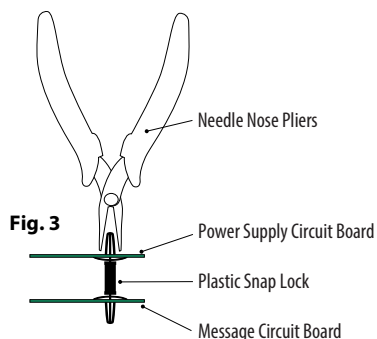

7. Replace all of the small white plastic board connectors that you removed in step 5. The connectors are keyed so they only plug in one way.

Fig. 4

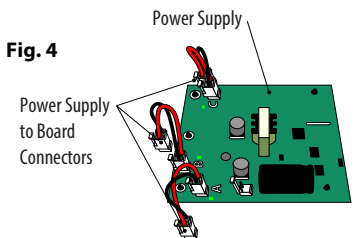

8. Replace the sign cabinet back on the top hinge point and plug the old wiring harness you removed in step 3, into the new power supply.

9. Close the sign cabinet and replace the screws removed from the bottom in step 2.

10. Yay you're done! Turn on the power to the sign.